

No.	Name	Note	No.	Name	Note
1	Angle valve	1/4" Flare	12	Angle valve	1/4" Flare
2	Discharge flange	4"	13	Refrigerant service valve	1/4" Flare
3	Solenoid valve	50%(NC)	14	Solenoid valve	Stepless(NC or NO), Option
4	Solenoid valve	75%(NC)	15	Liquid injection connector	5/8" Flare, Option
5	Solenoid valve	35%(NC)	16	Suction flange	5"
6	Liquid(oil or refrigerant) injection connector	3/8" Flare, Option	17	Cable box	Standard
7	Capillary		18	Service flange	
8	Check valve	4"	19	Oil drain valve	Option
9	Service flange		20	Discharge temp. sensor	110°C
10	Stop Pin		21	Safety Valve	1" NPT, Option
11	Oil inlet Connector	3/4" Flare	22	Economizer port	1 1/8", Solder

**\*All stop valves are optional.**

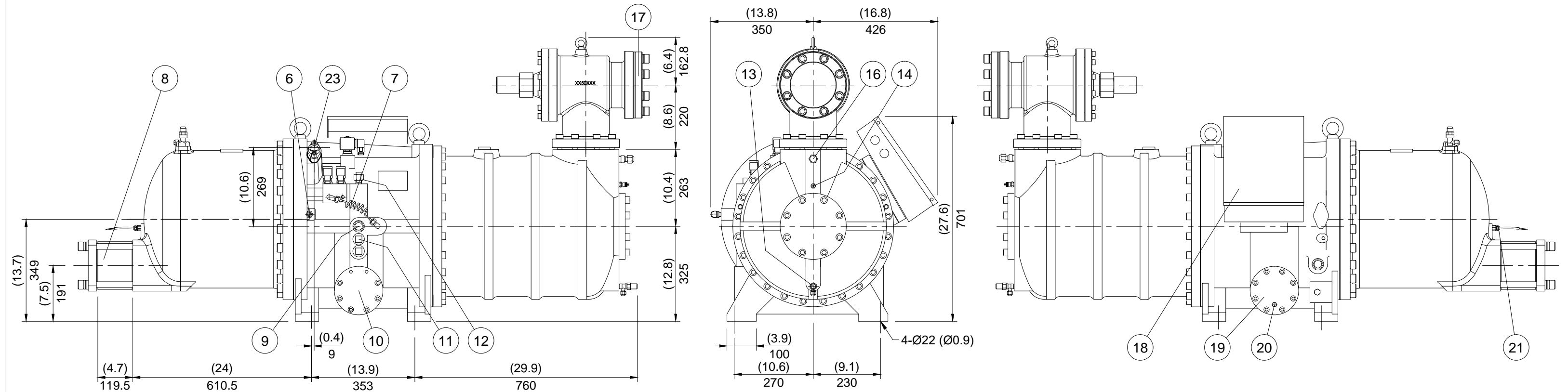

Dimensional Outline Drawing & Component Description for Stepless or Modulating-Type Capacity Control Application	
Hanbell Model	RC2-710BF
Date	06/26/2024
Drawn By	ILM



**Micro Control Systems, Inc.**  
 5877 Enterprise Parkway  
 Fort Myers, Florida 33905  
 Tel. (239) 694-0089 Fax (239) 694-0031  
 E-mail: compressors@mcscontrols.com

Model	RC2-710BF
Name	Compressor outline
	HANBELL
Ver.	05

UNIT  
 SI: mm Imperial: (in)